



4" SUBMERSIBLE PUMP

4" SUBMERSIBLE PUMP

ST / GS SERIES (stainless steel) SL SERIES (thermoplastic)

The "ST / GS / SL" series are built with such precision that they provide a superior output for many years. These submersible are also built to work under tough conditions even in abrasive water.

ST Series (stainless steel)

Check valve - External check valve made of stainless steel
Discharge head & Motor bracket - Made of (304) stainless steel.

SL Series (thermoplastic)

Check valve - Internal check valve made of Polypropylène + fiber.
Discharge head & Motor bracket - Injection nolded in Polypropylène + fiber

GS Series (stainless steel)

Check valve - Internal check valve made of Acetal.
Discharge head & Motor bracket - Made of (304) stainless steel.

"ST / SL / GS" series

Shaft - Hexagonal shaft made of (303) stainless steel for corrosion and wear resistance.

Couplings - Made of stainless steel and fit perfectly to any 4" standard motor witch allows maximum efficiency.

Diffuser - Injection molded in Noryl.

Washer - Made of stainless steel, prevents wearing of the impellers and the diffusers.

Impeller - Injection molded in Polycarbonate.

Disc - Made of stainless steel

All parts (diffuser, impeller and disc) are designed to resist wearing in abrasive water.

Top bearing - Injection molded in Polypropylene plus fibers, with a rubber centre for an even more precise alignment of the shaft. The rubber center considerably reduces wearing of the shaft caused by sand.

Screen - Made of stainless steel, prevents the impellers from large debris obstructions

Cable guard - Made of stainless steel, corrosion resistant, protects motor lead.

Housing - Made of (T-304) stainless steel, threaded for easy maintenance.

Fasteners - All stainless steel fasteners.

Motor



"ST" series



"SL" series



"GS" series





4" SUBMERSIBLE PUMP STAINLESS STEEL ST

4" Submersible pump "ST" series

INCLUDED: PUMP - MOTOR - LEAD

Bracket and discharge head made in **stainless steel (304)**, external check valve, shaft and pump housing made in stainless steel



H.P.	G.P.M.	Stages	Phase	Volts	3 WIRES + GROUND			2 WIRES + GROUND		
					Order number	Model	Price list	Order number	Model	Price list
1/2	5	13	1	115	531-0077	ST5-50-113	816.00	531-0075	ST5-50-112	876.00
			1	230	531-0087	ST5-50-233	816.00	531-0085	ST5-50-232	876.00
	8	9	1	115	531-0097	ST8-50-113	770.00	531-0095	ST8-50-112	834.00
			1	230	531-0107	ST8-50-233	770.00	531-0105	ST8-50-232	834.00
	12	8	1	115	531-0117	ST12-50-113	718.00	531-0115	ST12-50-112	775.00
			1	230	531-0124	ST12-50-233	718.00	531-0125	ST12-50-232	775.00
20	4	1	115	531-0057	ST20-50-113	751.00	531-0127	ST20-50-112	824.00	
		1	230	531-0067	ST20-50-233	751.00	531-0129	ST20-50-232	778.00	
3/4	5	19	1	230	531-0137	ST5-75-233	1 006.00	531-0135	ST5-75-232	1 082.00
			3	200	531-0131	ST5-75-200	1 000.00			
			3	230	531-0132	ST5-75-230	1 000.00			
			3	460	531-0133	ST5-75-460	1 000.00			
	8	13	1	230	531-0147	ST8-75-233	938.00	531-0145	ST8-75-232	1 022.00
			3	200	531-0141	ST8-75-200	933.00			
			3	230	531-0142	ST8-75-230	933.00			
			3	460	531-0143	ST8-75-460	933.00			
	12	11	1	230	531-0157	ST12-75-233	855.00	531-0155	ST12-75-232	928.00
			3	200	531-0151	ST12-75-200	849.00			
			3	230	531-0152	ST12-75-230	849.00			
			3	460	531-0153	ST12-75-460	849.00			
	20	9	1	230	531-0167	ST20-75-233	908.00	531-0165	ST20-75-232	993.00
			3	200	531-0161	ST20-75-200	902.00			
			3	230	531-0162	ST20-75-230	902.00			
			3	460	531-0163	ST20-75-460	902.00			
1	5	22	1	230	531-0177	ST5-100-233	1 100.00	531-0175	ST5-100-232	1 204.00
			3	200	531-0171	ST5-100-200	1 121.00			
			3	230	531-0172	ST5-100-230	1 121.00			
			3	460	531-0173	ST5-100-460	1 121.00			
	8	16	1	230	531-0187	ST8-100-233	1 017.00	531-0185	ST8-100-232	1 134.00
			3	200	531-0181	ST8-100-200	1 040.00			
			3	230	531-0182	ST8-100-230	1 040.00			
			3	460	531-0183	ST8-100-460	1 040.00			
	12	14	1	230	531-0197	ST12-100-233	934.00	531-0195	ST12-100-232	1 061.00
			3	200	531-0191	ST12-100-200	956.00			
			3	230	531-0192	ST12-100-230	956.00			
			3	460	531-0193	ST12-100-460	956.00			
	20	11	1	230	531-0207	ST20-100-233	987.00	531-0205	ST20-100-232	1 134.00
			3	200	531-0201	ST20-100-200	1 013.00			
			3	230	531-0202	ST20-100-230	1 013.00			
			3	460	531-0203	ST20-100-460	1 013.00			

WARNING: These pumps may develop very high pressure. A pressure valve must be installed on the tank to avoid possible danger of the tank bursting that can cause property damage and/or personal injury or death.



4" SUBMERSIBLE PUMP STAINLESS STEEL ST

4" Submersible pump "ST" series

INCLUDED: PUMP - MOTOR - LEAD

Bracket and discharge head made in **stainless steel (304)**, external check valve, shaft and pump housing made in stainless steel

H.P.	G.P.M.	Stages	Phase	Volts	3 WIRES + GROUND			2 WIRES + GROUND		
					Order number	Model	Price list	Order number	Model	Price list
1 1/2	5	29	1	230	531-0217	ST5-150-233	1 473.00	531-0215	ST5-150-232	1 613.00
			3	200	531-0211	ST5-150-200	1 364.00			
			3	230	531-0212	ST5-150-230	1 364.00			
			3	460	531-0213	ST5-150-460	1 364.00			
	8	22	1	230	531-0237	ST8-150-233	1 339.00	531-0235	ST8-150-232	1 524.00
			3	200	531-0231	ST8-150-200	1 263.00			
			3	230	531-0232	ST8-150-230	1 263.00			
			3	460	531-0233	ST8-150-460	1 263.00			
	12	19	1	230	531-0257	ST12-150-233	1 278.00	531-0255	ST12-150-232	1 445.00
			3	200	531-0251	ST12-150-200	1 188.00			
			3	230	531-0252	ST12-150-230	1 188.00			
			3	460	531-0253	ST12-150-460	1 188.00			
	20	15	1	230	531-0277	ST20-150-233	1 308.00	531-0275	ST20-150-232	1 499.00
			3	200	531-0271	ST20-150-200	1 217.00			
			3	230	531-0272	ST20-150-230	1 217.00			
			3	460	531-0273	ST20-150-460	1 217.00			
2	8	28	1	230	531-0297	ST8-200-233	1 554.00			
			3	200	531-0291	ST8-200-200	1 407.00			
			3	230	531-0292	ST8-200-230	1 407.00			
			3	460	531-0293	ST8-200-460	1 407.00			
	12	21	1	230	531-0317	ST12-200-233	1 449.00			
			3	200	531-0311	ST12-200-200	1 334.00			
			3	230	531-0312	ST12-200-230	1 334.00			
			3	460	531-0313	ST12-200-460	1 334.00			
	20	19	1	230	531-0337	ST20-200-233	1 476.00			
			3	200	531-0331	ST20-200-200	1 358.00			
			3	230	531-0332	ST20-200-230	1 358.00			
			3	460	531-0333	ST20-200-460	1 358.00			
3	12	28	1	230	531-0357	ST12-300-233	2 230.00			
			3	200	531-0351	ST12-300-200	1 794.00			
			3	230	531-0352	ST12-300-230	1 794.00			
			3	460	531-0353	ST12-300-460	1 794.00			
	20	24	1	230	531-0377	ST20-300-233	2 284.00			
			3	200	531-0371	ST20-300-200	1 784.00			
			3	230	531-0372	ST20-300-230	1 784.00			
			3	460	531-0373	ST20-300-460	1 784.00			
5	20	34	1	230	531-0397	ST20-500-233	2 856.00			
			3	200	531-0391	ST20-500-200	2 624.00			
			3	230	531-0392	ST20-500-230	2 624.00			
			3	460	531-0393	ST20-500-460	2 624.00			

**PUMP
DISCHARGE 1 1/4"**

EXAMPLE OF MODEL NUMBER CODE

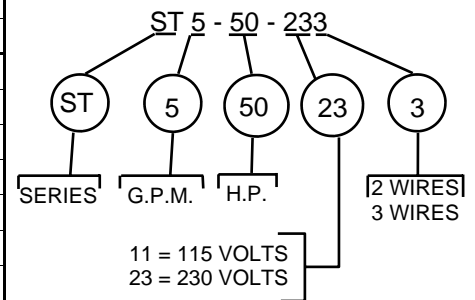



4" SUBMERSIBLE PUMP STAINLESS STEEL GS

4" Submersible pump "GS" series

INCLUDED: PUMP - MOTOR - LEAD

Bracket and discharge head made in **stainless steel (304)**, internal check valve, shaft and pump housing made in stainless steel



H.P.	G.P.M.	Stages	Phase	Volts	3 WIRES + GROUND			2 WIRES + GROUND		
					Order number	Model	Price list	Order number	Model	Price list
1/2	5	13	1	115	531-5077	5 GS05 113	801.00	531-5075	5 GS05 112	853.00
			1	230	531-5087	5 GS05 233	801.00	531-5085	5 GS05 232	853.00
	8	9	1	115	531-5097	8 GS05 113	754.00	531-5095	8 GS05 112	818.00
			1	230	531-5107	8 GS05 233	754.00	531-5105	8 GS05 232	818.00
	12	8	1	115	531-5117	12 GS05 113	702.00	531-5115	12 GS05 112	771.00
			1	230	531-5124	12 GS05 233	702.00	531-5125	12 GS05 232	771.00
	20	4	1	115	531-5057	20 GS05 113	735.00	531-5127	20 GS05 112	806.00
			1	230	531-5067	20 GS05 233	735.00	531-5129	20 GS05 232	806.00
3/4	5	19	1	230	531-5137	5 GS07 233	990.00	531-5135	5 GS07 232	1 053.00
			3	200	531-5131	5 GS07 200	984.00			
			3	230	531-5132	5 GS07 230	984.00			
			3	460	531-5133	5 GS07 460	984.00			
	8	13	1	230	531-5147	8 GS07 233	925.00	531-5145	8 GS07 232	1 006.00
			3	200	531-5141	8 GS07 200	917.00			
			3	230	531-5142	8 GS07 230	917.00			
			3	460	531-5143	8 GS07 460	917.00			
	12	11	1	230	531-5157	12 GS07 233	839.00	531-5155	12 GS07 232	925.00
			3	200	531-5152	12 GS07 200	833.00			
			3	230	531-5153	12 GS07 230	833.00			
			3	460	531-5159	12 GS07 460	833.00			
	20	9	1	230	531-5167	20 GS07 233	892.00	531-5165	20 GS07 232	973.00
			3	200	531-5161	20 GS07 200	887.00			
			3	230	531-5162	20 GS07 230	887.00			
			3	460	531-5163	20 GS07 460	887.00			
1	5	22	1	230	531-5177	5 GS10 233	1 085.00	531-5175	5 GS10 232	1 179.00
			3	200	531-5171	5 GS10 200	1 106.00			
			3	230	531-5172	5 GS10 230	1 106.00			
			3	460	531-5173	5 GS10 460	1 106.00			
	8	16	1	230	531-5187	8 GS10 233	1 001.00	531-5185	8 GS10 232	1 121.00
			3	200	531-5181	8 GS10 200	1 024.00			
			3	230	531-5182	8 GS10 230	1 024.00			
			3	460	531-5183	8 GS10 460	1 024.00			
	12	14	1	230	531-5197	12 GS10 233	918.00	531-5195	12 GS10 232	1 056.00
			3	200	531-5191	12 GS10 200	940.00			
			3	230	531-5192	12 GS10 230	940.00			
			3	460	531-5193	12 GS10 460	940.00			
	20	11	1	230	531-5207	20 GS10 233	972.00	531-5205	20 GS10 232	1 108.00
			3	200	531-5201	20 GS10 200	998.00			
			3	230	531-5202	20 GS10 230	998.00			
			3	460	531-5203	20 GS10 460	998.00			



4" SUBMERSIBLE PUMP STAINLESS STEEL GS

4" Submersible pump "GS" series

INCLUDED: PUMP - MOTOR - LEAD

Bracket and discharge head made in **stainless steel (304)**, internal check valve, shaft and pump housing made in stainless steel

H.P.	G.P.M.	Stages	Phase	Volts	3 WIRES + GROUND			2 WIRES + GROUND		
					Order number	Model	Price list	Order number	Model	Price list
1 1/2	5	29	1	230	531-5217	5 GS15 233	1 458.00	531-5215	5 GS15 232	1 596.00
			3	200	531-5211	5 GS15 200	1 350.00			
			3	230	531-5212	5 GS15 230	1 350.00			
			3	460	531-5213	5 GS15 460	1 350.00			
	8	22	1	230	531-5237	8 GS15 233	1 323.00	531-5235	8 GS15 232	1 508.00
			3	200	531-5231	8 GS15 200	1 250.00			
			3	230	531-5232	8 GS15 230	1 250.00			
			3	460	531-5233	8 GS15 460	1 250.00			
	12	19	1	230	531-5257	12 GS15 233	1 263.00	531-5255	12 GS15 232	1 429.00
			3	200	531-5251	12 GS15 200	1 172.00			
			3	230	531-5252	12 GS15 230	1 172.00			
			3	460	531-5253	12 GS15 460	1 172.00			
20	15	1	230	531-5277	20 GS15 233	1 292.00	531-5275	20 GS15 232	1 483.00	
		3	200	531-5271	20 GS15 200	1 203.00				
		3	230	531-5272	20 GS15 230	1 203.00				
		3	460	531-5273	20 GS15 460	1 203.00				
2	8	28	1	230	531-5297	8 GS20 233	1 539.00			
			3	200	531-5291	8 GS20 200	1 392.00			
			3	230	531-5292	8 GS20 230	1 392.00			
			3	460	531-5293	8 GS20 460	1 392.00			
	12	21	1	230	531-5317	12 GS20 233	1 434.00			
			3	200	531-5311	12 GS20 200	1 318.00			
			3	230	531-5312	12 GS20 230	1 318.00			
			3	460	531-5313	12 GS20 460	1 318.00			
	20	19	1	230	531-5337	20 GS20 233	1 460.00			
			3	200	531-5331	20 GS20 200	1 344.00			
			3	230	531-5332	20 GS20 230	1 344.00			
			3	460	531-5333	20 GS20 460	1 344.00			
3	12	28	1	230	531-5357	12 GS30 233	2 216.00			
			3	200	531-5351	12 GS30 200	1 780.00			
			3	230	531-5352	12 GS30 230	1 780.00			
			3	460	531-5353	12 GS30 460	1 780.00			
	20	24	1	230	531-5377	20 GS30 233	2 268.00			
			3	200	531-5371	20 GS30 200	1 770.00			
			3	230	531-5372	20 GS30 230	1 770.00			
			3	460	531-5373	20 GS30 460	1 770.00			
5	20	34	1	230	531-5397	20 GS50 233	2 841.00			
			3	200	531-5391	20 GS50 200	2 610.00			
			3	230	531-5392	20 GS50 230	2 610.00			
			3	460	531-5393	20 GS50 460	2 610.00			

PUMP DISCHARGE 1 1/4"

EXAMPLE OF MODEL NUMBER CODE

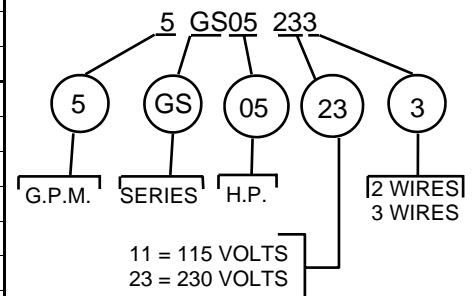



4" SUBMERSIBLE PUMP THERMOPLASTIC SL

4" Submersible pump "SL" series

INCLUDED: PUMP - MOTOR - LEAD

Bracket and discharge head made in **thermoplastic**, internal check valve, shaft and pump housing made in stainless steel



H.P.	G.P.M.	Stages	Phase	Volts	3 WIRES + GROUND			2 WIRES + GROUND		
					Order number	Model	Price list	Order number	Model	Price list
1/2	5	13	1	115	567-0077	SL5-50-113	701.00	567-0075	SL5-50-112	771.00
			1	230	567-0087	SL5-50-233	701.00	567-0085	SL5-50-232	771.00
	8	9	1	115	567-0097	SL8-50-113	665.00	567-0095	SL8-50-112	736.00
			1	230	567-0107	SL8-50-233	665.00	567-0105	SL8-50-232	736.00
	12	8	1	115	567-0117	SL12-50-113	636.00	567-0115	SL12-50-112	694.00
			1	230	567-0124	SL12-50-233	636.00	567-0125	SL12-50-232	694.00
	20	4	1	115	567-0057	SL20-50-113	641.00	567-0127	SL20-50-112	712.00
			1	230	567-0067	SL20-50-233	641.00	567-0129	SL20-50-232	712.00
3/4	5	19	1	230	567-0137	SL5-75-233	897.00	567-0135	SL5-75-232	974.00
			3	200	567-0131	SL5-75-200	892.00			
			3	230	567-0132	SL5-75-230	892.00			
			3	460	567-0133	SL5-75-460	892.00			
	8	13	1	230	567-0147	SL8-75-233	832.00	567-0145	SL8-75-232	923.00
			3	200	567-0141	SL8-75-200	827.00			
			3	230	567-0142	SL8-75-230	827.00			
	12	11	3	460	567-0143	SL8-75-460	827.00			
			1	230	567-0157	SL12-75-233	766.00	567-0155	SL12-75-232	849.00
			3	200	567-0151	SL12-75-200	761.00			
			3	230	567-0152	SL12-75-230	761.00			
	20	9	3	460	567-0153	SL12-75-460	761.00			
			1	230	567-0167	SL20-75-233	794.00	567-0165	SL20-75-232	884.00
			3	200	567-0161	SL20-75-200	789.00			
			3	230	567-0162	SL20-75-230	789.00			
	1	8	16	1	230	567-0187	SL8-100-233	907.00	567-0185	SL8-100-232
3				200	567-0181	SL8-100-200	921.00			
3				230	567-0182	SL8-100-230	921.00			
3				460	567-0183	SL8-100-460	921.00			
12		14	1	230	567-0197	SL12-100-233	854.00	567-0195	SL12-100-232	980.00
			3	200	567-0191	SL12-100-200	870.00			
			3	230	567-0192	SL12-100-230	870.00			
			3	460	567-0193	SL12-100-460	870.00			
20		11	1	230	567-0207	SL20-100-233	878.00	567-0205	SL20-100-232	1 008.00
			3	200	567-0201	SL20-100-200	896.00			
			3	230	567-0202	SL20-100-230	896.00			
			3	460	567-0203	SL20-100-460	896.00			
1 1/2	20	15	1	230	567-0277	SL20-150-233	1173.00	567-0275	SL20-150-232	1 355.00
			3	200	567-0271	SL20-150-200	1087.00			
			3	230	567-0272	SL20-150-230	1087.00			
			3	460	567-0273	SL20-150-460	1087.00			

**PUMP
DISCHARGE 1 1/4"**

WARNING: These pumps may develop very high pressure. A pressure valve must be installed on the tank to avoid possible danger of the tank bursting that can cause property damage and/or personal injury or death.



4" SUBMERSIBLE PUMP PUMP END



4" Submersible pump PUMP END (5 - 8 - 12 - 20 GPM)

H.P.	G.P.M.	Stages	"ST" SERIE			"GS" SERIE			"SL" SERIE		
			Number	Model	Price	Number	Model	Price	Number	Model	Price
1/2	5	13	532-0011	ST5-50	438.50	532-5011	5 GS05	431.30	566-0011	SL5-50	305.60
	8	9	532-0061	ST8-50	420.20	532-5061	8 GS05	386.60	566-0061	SL8-50	256.60
	12	8	532-0121	ST12-50	374.40	532-5121	12 GS05	353.30	566-0121	SL12-50	244.80
	20	4	532-0176	ST20-50	331.50	532-5176	20 GS05	331.00	566-0171	SL20-50	201.10
3/4	5	19	532-0021	ST5-75	555.20	532-5021	5 GS07	522.30	566-0021	SL5-75	384.60
	8	13	532-0071	ST8-75	461.80	532-5071	8 GS07	434.10	566-0071	SL8-75	305.90
	12	11	532-0131	ST12-75	423.40	532-5131	12 GS07	402.40	566-0131	SL12-75	281.30
	20	9	532-0181	ST20-75	400.80	532-5181	20 GS07	400.20	566-0181	SL20-75	263.40
1	5	22	532-0031	ST5-100	614.50	532-5031	5 GS10	584.50			
	8	16	532-0081	ST8-100	498.00	532-5081	8 GS10	471.20	566-0081	SL8-100	344.30
	12	14	532-0141	ST12-100	459.40	532-5141	12 GS10	438.00	566-0141	SL12-100	317.80
	20	11	532-0191	ST20-100	447.10	532-5191	20 GS10	434.20	566-0191	SL20-100	290.00
1 1/2	5	29	532-0041	ST5-150	762.70	532-5041	5 GS15	742.50			
	8	22	532-0091	ST8-150	658.60	532-5091	8 GS15	642.00			
	12	19	532-0151	ST12-150	585.90	532-5151	12 GS15	583.40			
	20	15	532-0201	ST20-150	619.50	532-5201	20 GS15	601.80	566-0201	SL20-150	359.50
2	8	28	532-0101	ST8-200	751.00	532-5101	8 GS20	744.70			
	12	21	532-0161	ST12-200	654.30	532-5161	12 GS20	650.20			
	20	19	532-0211	ST20-200	666.90	532-5211	20 GS20	663.50	566-0221	SL20-200	458.30
3	12	28	532-0171	ST12-300	993.70	532-5171	12 GS30	980.50			
	20	24	532-0221	ST20-300	1 039.70	532-5221	20 GS30	1 026.00			
5	20	34	532-0231	ST20-500	1 122.30	532-5231	20 GS50	1 112.80			

4" Submersible pump "SLP" series (35 - 50 GPM)

Bracket and discharge head made in **thermoplastic**, internal check valve, shaft and pump housing made in stainless steel



SLP

H.P.	G.P.M.	Stages	Pump end			Pump + motor (230 V - 1 phase)		
			Order number	Model	Price	Order number	Model	Price
1	35	4	566-0311	SLP35-10	305.00	567-0505	SLP35-10-232	1 038.00
						567-0507	SLP35-10-233	886.00
1 1/2	35	6	566-0321	SLP35-15	364.80	567-0552	SLP35-15-232	1 359.00
						567-0557	SLP35-15-233	1 172.00
	50	4	566-0371	SLP50-15	357.30	567-0575	SLP50-15-232	1 319.00
						567-0577	SLP50-15-233	1 137.00
2	35	7	566-0331	SLP35-20	385.80	567-0597	SLP35-20-233	1 328.00
	50	5	566-0381	SLP50-20	404.30	567-0627	SLP50-20-233	1 277.00

* Available (200 - 230 - 380 - 3 phases) on request



4" SUBMERSIBLE PUMP FP

4" Submersible pump (35-50-80 GPM)

INCLUDED: PUMP - MOTOR - LEAD



H.P.	G.P.M.	Stages	230 Volts - 1 phase			460 Volts - 3 phases		
			Order number	Model	Price	Order number	Model	Price
1	35	4	544-0005	4 FP-35-10-232	1 111.00			
			544-0011	4 FP-35-10-233	957.00			
1½	35	6	544-0045	4 FP-35-15-232	1 416.00	544-0075	4 FP-35-15-460	1 173.00
			544-0051	4 FP-35-15-233	1 205.00			
	50	4	544-0085	4 FP-50-15-232	1 335.00	544-0115	4 FP-50-15-460	1 140.00
			544-0091	4 FP-50-15-233	1 188.00			
2	35	7	544-0131	4 FP-35-20-233	1 351.00	544-0155	4 FP-35-20-460	1 237.00
	50	5	544-0171	4 FP-50-20-233	1 313.00	544-0195	4 FP-50-20-460	1 223.00
3	35	10	544-0211	4 FP-35-30-233	1 888.00	544-0235	4 FP-35-30-460	1 725.00
	50	7	544-0251	4 FP-50-30-233	1 833.00	544-0275	4 FP-50-30-460	1 664.00
	80	5	544-0291	4 FP-80-30-233	1 820.00	544-0315	4 FP-80-30-460	1 650.00
5	35	16	544-0331	4 FP-35-50-233	2 560.00	544-0355	4 FP-35-50-460	2 435.00
	50	10	544-0371	4 FP-50-50-233	2 513.00	544-0395	4 FP-50-50-460	2 355.00
	80	7	544-0411	4 FP-80-50-233	2 481.00	544-0435	4 FP-80-50-460	2 327.00
7½	35	27				544-0475	4 FP-35-75-460	3 322.00
	50	17				544-0515	4 FP-50-75-460	3 128.00
	80	14				544-0555	4 FP-80-75-460	3 190.00
10	35					544-0595	4 FP-35-100-460	4 675.00
	50	22				544-0635	4 FP-50-100-460	4 435.00
	80	19				544-0675	4 FP-80-100-460	4 640.00

CHARACTERISTICS

- Impellers and diffusers made of polycarbonate
- Pump shaft and shell made of 304 stainless steel
- Internal check valve included
- Discharge = 2"
- Maximum starts for in hour = 15

* Available (200 - 230 -380 - 460 - 3 phases)

4" PUMP END (35 - 50 - 80 GPM)

H.P.	G.P.M.	Stages	Order number	Model	Price
1	35	4	545-0010	4 FP-35-10	506.00
1½	35	6	545-0050	4 FP-35-15	608.00
	50	4	545-0090	4 FP-50-15	604.00
2	35	7	545-0130	4 FP-35-20	642.00
	50	5	545-0170	4 FP-50-20	630.00
3	35	10	545-0210	4 FP-35-30	745.00
	50	7	545-0250	4 FP-50-30	736.00
	80	5	545-0290	4 FP-80-30	711.00
5	35	16	545-0330	4 FP-35-50	1 043.00
	50	10	545-0370	4 FP-50-50	1 016.00
	80	7	545-0410	4 FP-80-50	996.00
7½	35	27	545-0450	4 FP-35-75	1 436.00
	50	17	545-0490	4 FP-50-75	1 307.00
	80	14	545-0530	4 FP-80-75	1 431.00
10	35		545-0570	4 FP-35-100	1 812.00
	50	22	545-0610	4 FP-50-100	1 678.00
	80	19	545-0650	4 FP-80-100	2 058.00

EXAMPLE OF MODEL NUMBER CODE

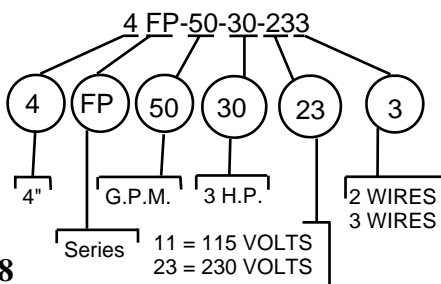

C-8



6" SUBMERSIBLE PUMP AP

6" SUBMERSIBLE PUMPS (120 - 170 - 230 GPM)

			PUMP + 460 Volts - 3 phases MOTOR			PUMP END		
H.P.	G.P.M.	Stages	Order number	Model	Price	Order number	Model	Price
7½	120	3	546-1015	46 AP-120-75-460	3 660.00	547-1010	46 AP-120-75	1739.00
			546-1055	66 AP-120-75-460	4265.00	547-1050	66 AP-120-75	1778.00
	170	2	546-1095	46 AP-170-75-460	3590.00	547-1090	46 AP-170-75	1641.00
			546-1135	66 AP-170-75-460	4197.00	547-1130	66 AP-170-75	1675.00
10	120	5	546-1175	66 AP-120-100-460	4 871.00	547-1170	66 AP-120-100	2114.00
	170	3	546-1215	66 AP-170-100-460	4 660.00	547-1210	66 AP-170-100	1813.00
	230	3	546-1255	66 AP-230-100-460	4 322.00	547-1250	66 AP-230-100	1549.00
15	120	7	546-1295	66 AP-120-150-460	5 718.00	547-1290	66 AP-120-150	2488.00
	230	4	546-1375	66 AP-230-150-460	5 371.00	547-1370	66 AP-230-150	1946.00
20	120	10	546-1415	66 AP-120-200-460	7 006.00	547-1410	66 AP-120-200	3029.00
	170	6	546-1455	66 AP-170-200-460	6 538.00	547-1450	66 AP-170-200	2363.00
	230	6	546-1495	66 AP-230-200-460	6 509.00	547-1490	66 AP-230-200	2332.00
25	120	12	546-1535	66 AP-120-250-460	8 171.00	547-1530	66 AP-120-250	3243.00
	170	8	546-1575	66 AP-170-250-460	7 675.00	547-1570	66 AP-170-250	2880.00
	230	7	546-1615	66 AP-230-250-460	7 540.00	547-1610	66 AP-230-250	2612.00
30	120	15	546-1655	66 AP-120-300-460	9 507.00	547-1650	66 AP-120-300	4117.00
	170	9	546-1695	66 AP-170-300-460	8 794.00	547-1690	66 AP-170-300	3435.00
	230	9	546-1735	66 AP-230-300-460	8 764.00	547-1730	66 AP-230-300	3021.00
40	230	12	546-1845	66 AP-230-400-460	10 494.00	547-1840	66 AP-230-400	3505.00

CHARACTERISTICS

- Impellers and diffusers made of Noryl
 - Pump shaft and shell made of 304 stainless steel
 - Internal check valve included
 - Discharge = 3"
 - Maximum starts for in hour = 15
- * Available (200 - 230 -380 - 460 - 3 phase) on request

EXAMPLE OF MODEL NUMBER CODE

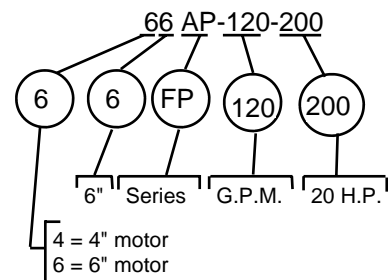



5 GPM

PUMPING CURVES 5 G.P.M. "ST / SL / GS" Series

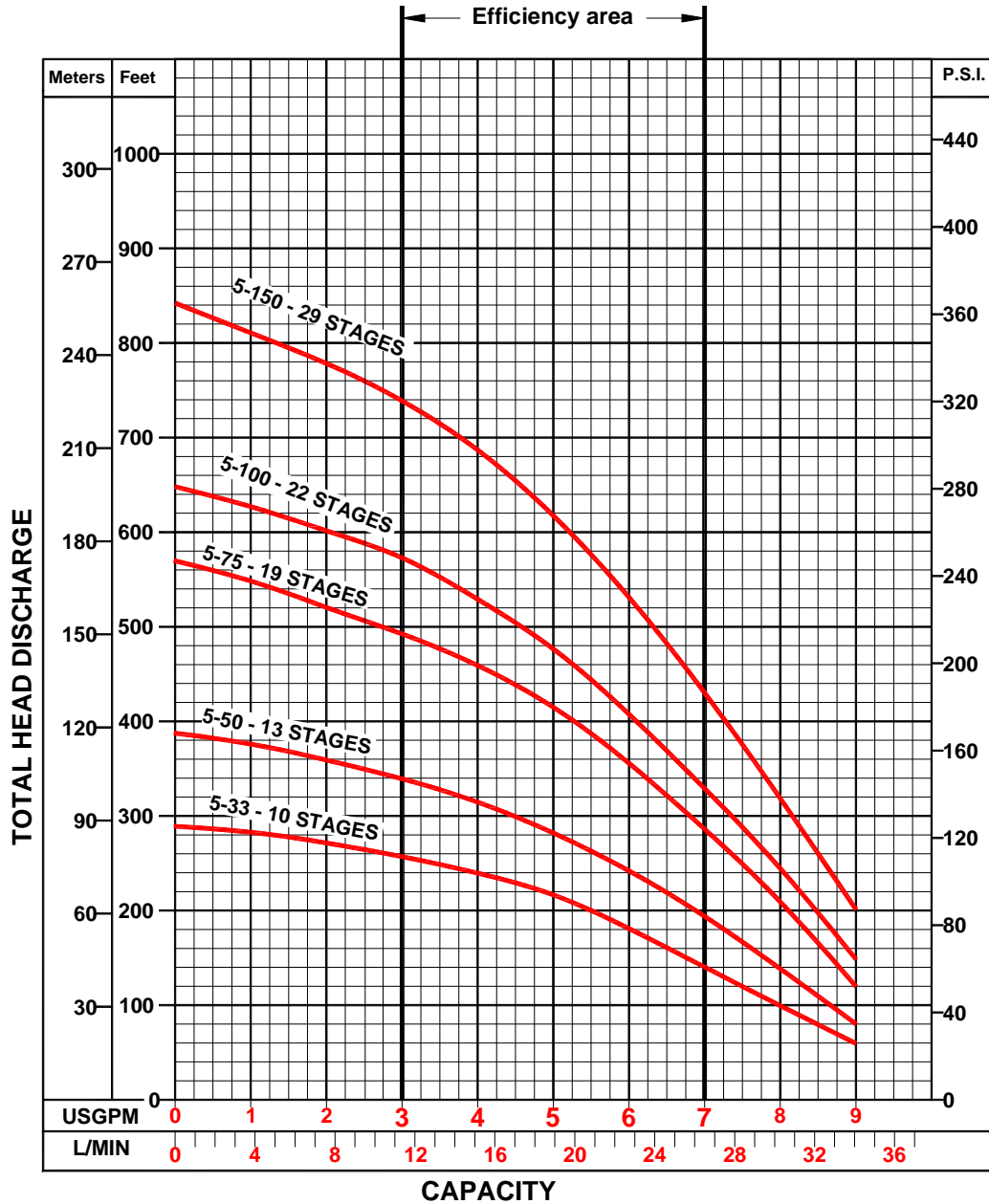

HP	Water depth in feet, capacity GPM, at 40 Psi.																				
	20	40	60	80	100	125	150	175	200	225	250	275	300	350	400	450	500	550	600	650	
1/2	8.5	8.2	7.8	7.5	7.1	6.7	6.1	5.5	4.8	4	3	1.6									
3/4	9.1	8.9	8.7	8.4	8.2	7.9	7.6	7.3	6.9	6.6	6.3	5.8	5.4	4.4	3.1						
1						8.3	8	7.8	7.4	7.2	6.9	6.6	6.3	5.6	4.8	3.8	2.4				
1 1/2						8.9	8.7	8.5	8.3	8.1	7.8	7.6	7.4	6.9	6.4	5.9	5.3	4.7	3.9	2.9	



8 GPM

PUMPING CURVES 8 G.P.M. "ST / SL / GS" Series

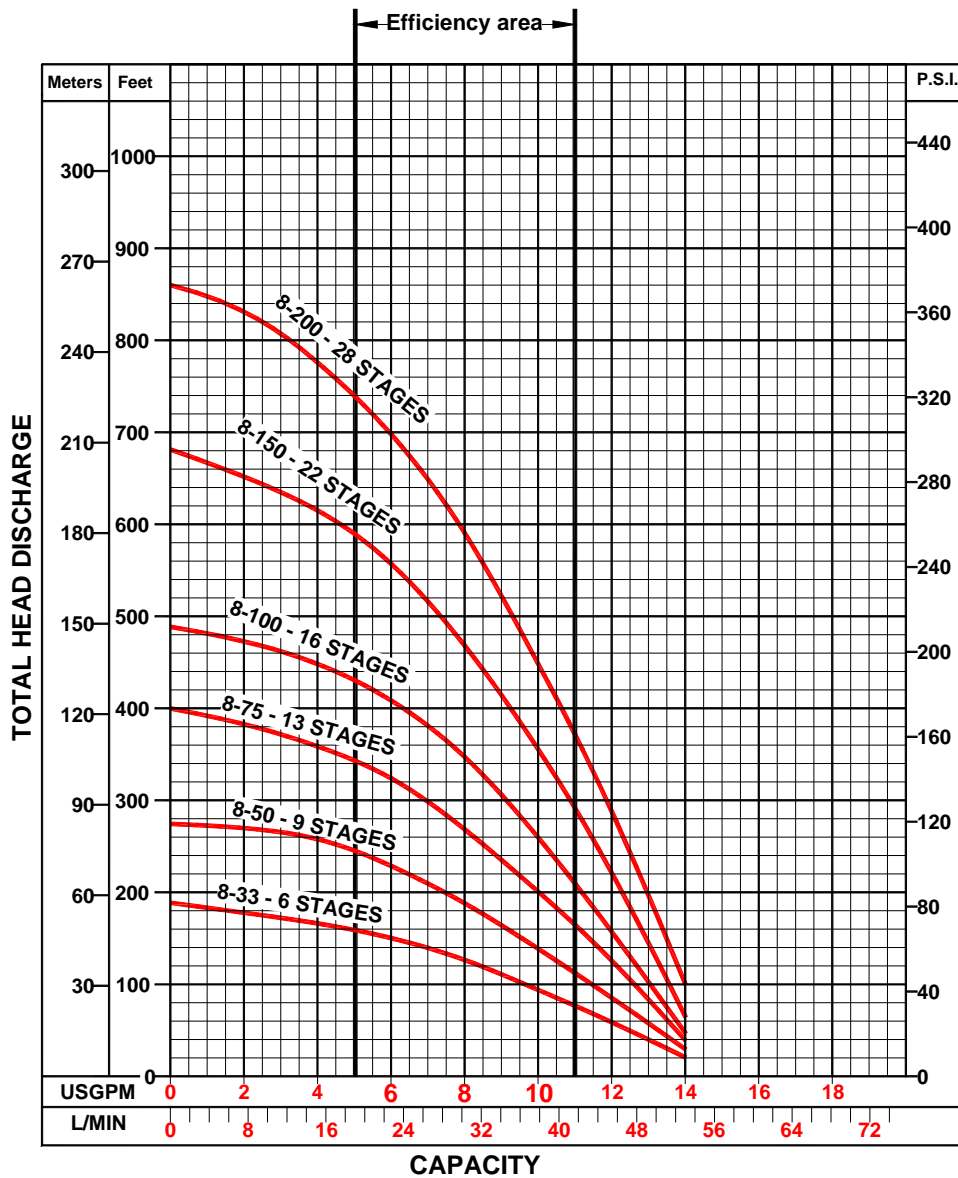

HP	Water depth in feet, capacity GPM, at 40 Psi.																				
	20	40	60	80	100	125	150	175	200	225	250	275	300	350	400	450	500	550	600	650	700
1/2	11.3	10.5	9.8	8.9	8	6.7	5	2.3													
3/4	12.4	11.9	11.4	10.9	10.4	9.8	9	8.2	7.3	6.4	5.3	3.8	1.7								
1	13	12.7	12.3	11.8	11.5	11	10.4	9.8	9.2	8.6	7.8	7.1	6.3	4.2							
1.5						12.2	11.8	11.4	11	10.7	10.2	9.8	9.3	8.4	7.4	6.3	4.8	2.8			
2						12.8	12.6	12.3	12	11.8	11.4	11.2	10.8	10.2	9.5	8.8	8	7.2	6.3	5.2	3.7



12 GPM

PUMPING CURVES 12 G.P.M. "ST / SL / GS" Series

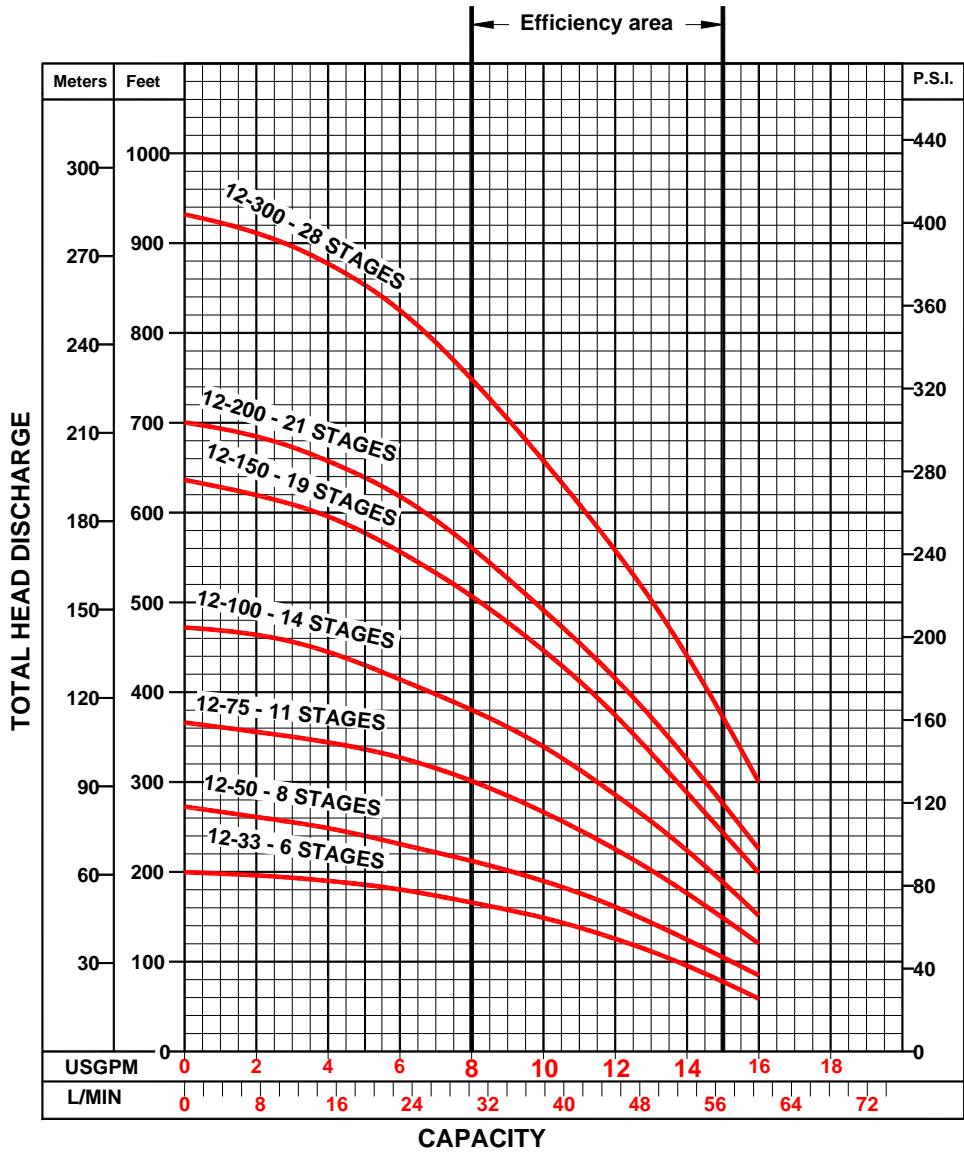

HP	Water depth in feet, capacity GPM, at 40 Psi.																				
	20	40	60	80	100	125	150	175	200	225	250	275	300	350	400	450	500	550	600	650	700
1/2	14.8	13.8	12.6	11.3	9.8	7.6	4.7														
3/4	16.1	15.5	14.9	14.3	13.6	12.5	11.2	9.8	8.3	6.58	4.4										
1	16.8	16.4	16	15.6	15.1	14.4	13.7	12.8	11.9	11	9.8	8.7	7.3	4.1							
1.5						15.8	15.3	14.8	14.3	13.7	13	12.3	11.6	10.1	8.5	6.7	4.4				
2						16.1	15.7	15.3	14.8	14.3	13.8	13.3	12.7	11.3	10	8.5	7	5.1			
3						16.9	16.7	16.4	16.1	15.8	15.5	15.2	14.8	14	13.2	12.3	11.3	10.3	9.2	8.1	6.8



20 GPM

PUMPING CURVES 20 G.P.M. "ST / SL / GS" Series

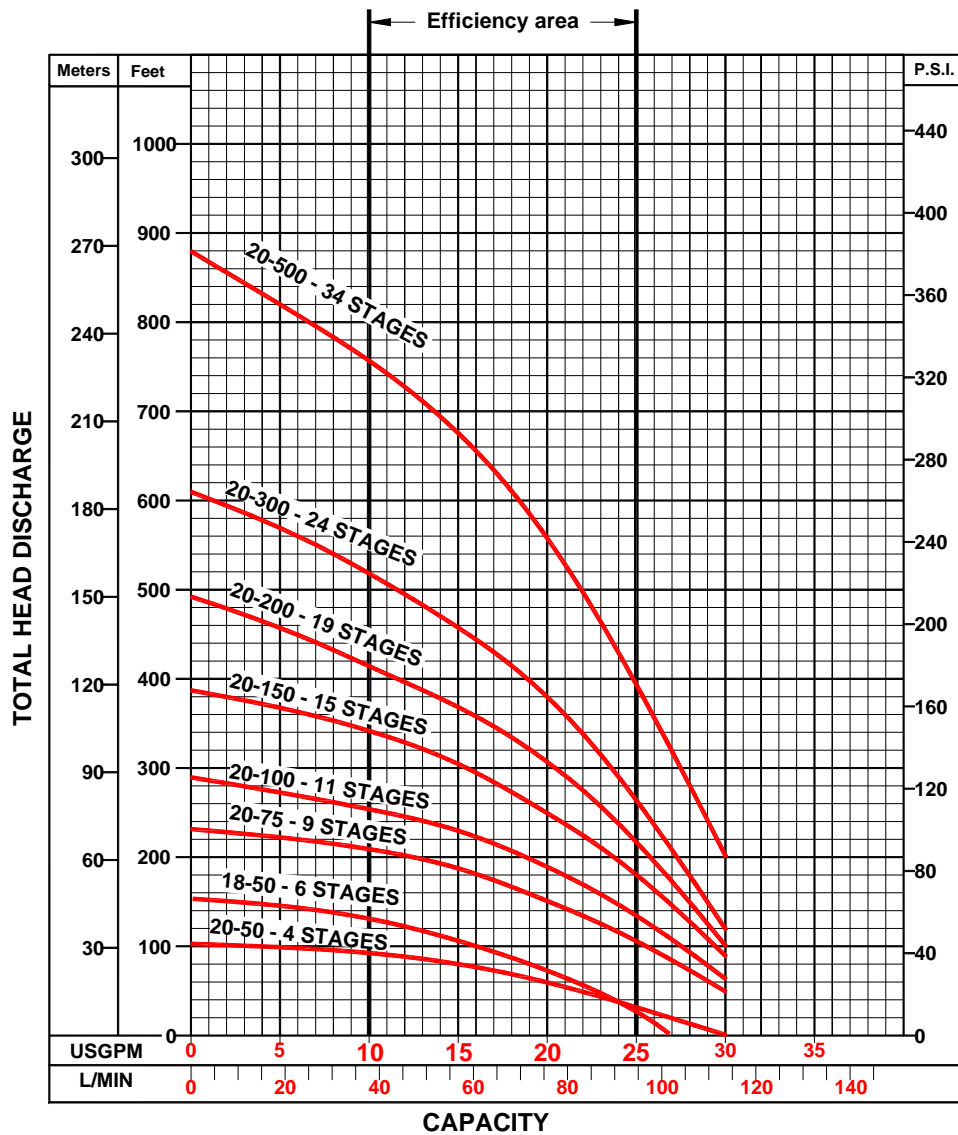

HP	Water depth in feet, capacity GPM, at 40 Psi.																					
	20	40	60	80	100	125	150	175	200	225	250	275	300	350	400	450	500	550	600	650	700	
3/4	24.8	22.8	20.3	17.3	12.7	6																
1	26.8	25.2	23.5	21.9	20	16.5	11.3	5.3														
1.5		27.7	26.7	25.6	24.3	22.8	21	18.8	16.2	12.5	8.5											
2		28.9	28.1	27.2	26.2	25	23.7	22.3	20.8	19.1	17.3	15.3	12.5	6								
3								25	24	23	22	20.9	19.8	16.8	29.2	7.2						
5								28.6	28	27.4	26.8	26.2	25.5	24.1	22.7	21	19.2	17.2	14.5	11	7	



35 GPM

4" PUMPING CURVES 35 G.P.M. "FP" Series

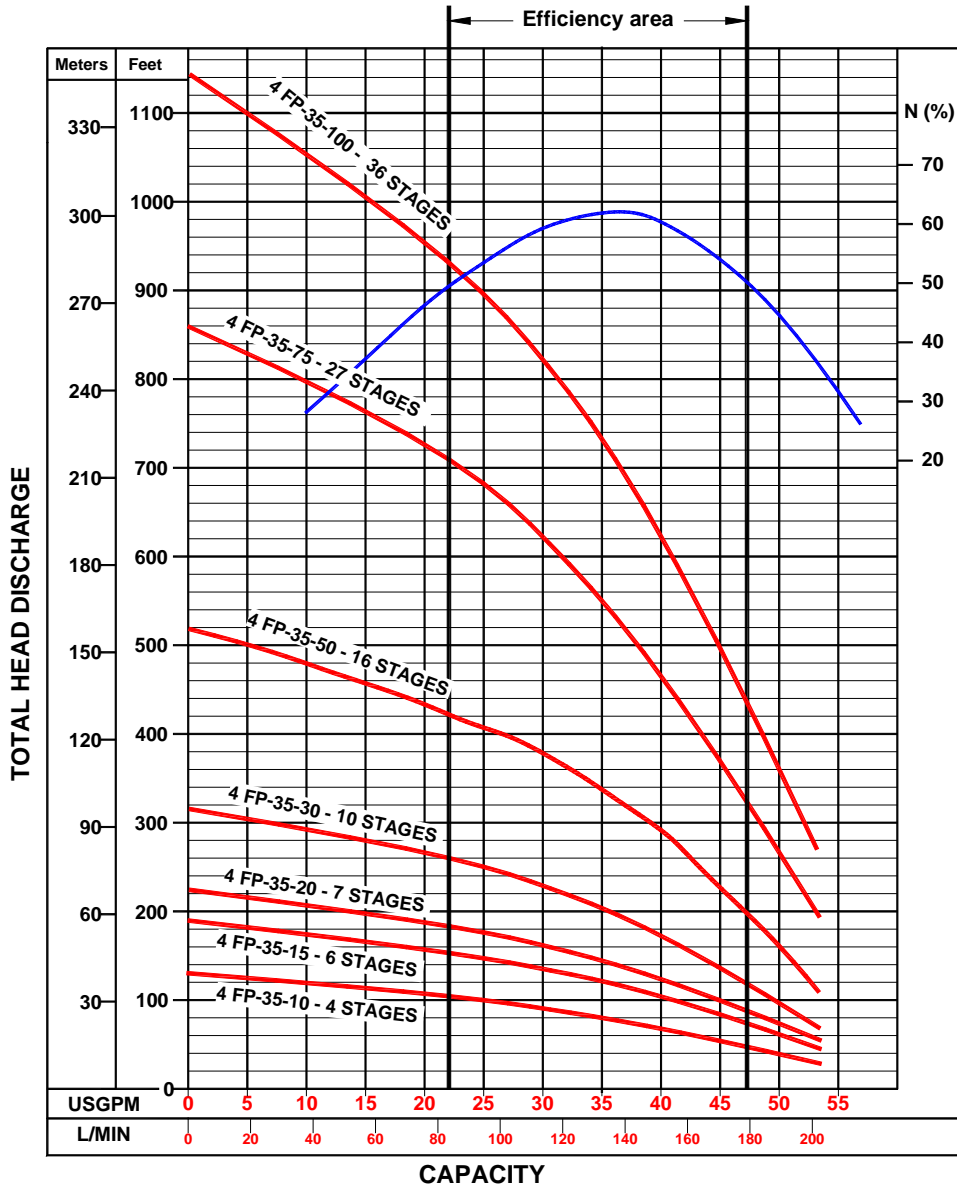

HP	Water depth in feet, capacity GPM, at 40 Psi.																						
	20	40	60	80	100	125	150	175	200	225	250	275	300	350	400	450	500	550	600	650	700	800	900
1	18																						
1.5	38	33	26	13																			
2	42	37	35	26	21	5																	
3		48	43	40	38	33	28	21	13														
5					48	46	44	42	40	37	35	32	28	19	8								
7.5									47	46.5	46	45.5	45	42	39	36	33	30	24	19	10		
10									51	50.3	49.5	48.8	48	46	45	43	41	38	36	34	32	25	18



50 GPM

4" PUMPING CURVES 50 G.P.M. "FP" Series

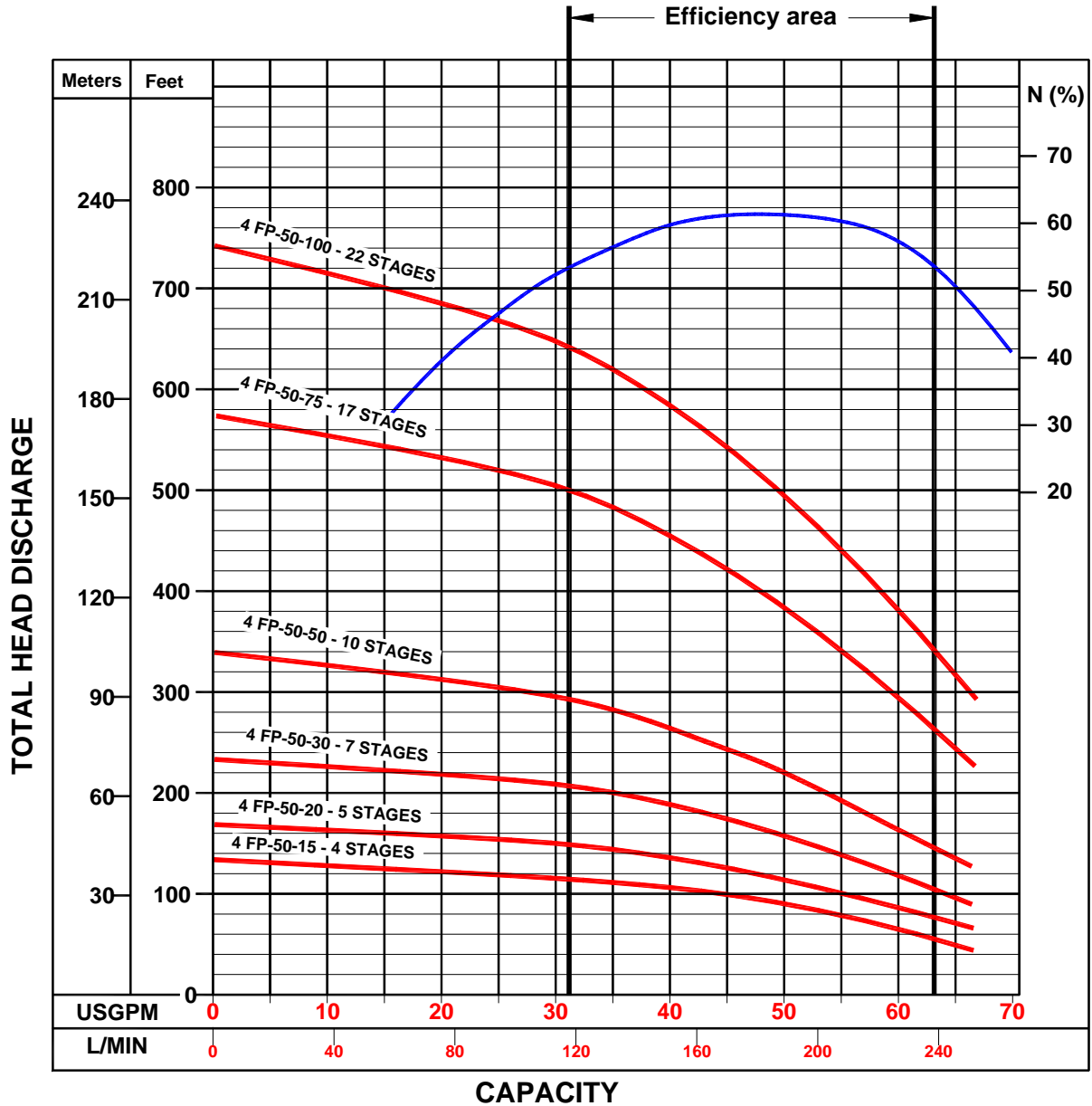

HP	Water depth in feet, capacity GPM, at 40 Psi.															
	20	40	60	80	100	125	150	200	250	300	350	400	450	500	550	600
1.5	35															
2	63	51	46	32	15											
3	61	59	54	47	40	25										
5			62	58	56	51	46	36								
7.5					69	67	65	60	56	51	45	35	18			
10							69	66	63	60	56	51	47	41	35	20



80 GPM

4" PUMPING CURVES 80 G.P.M. "FP" Series

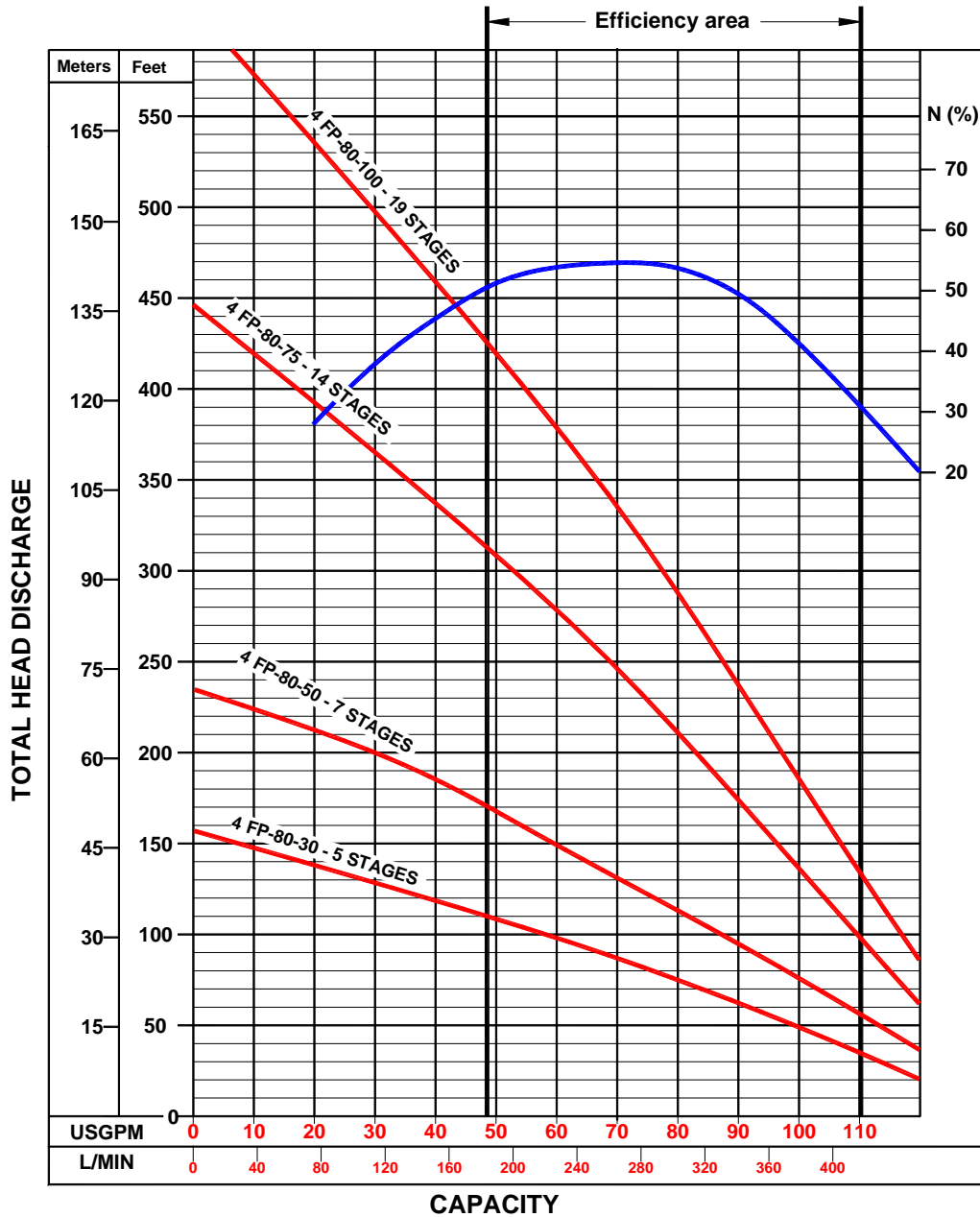

HP	Water depth in feet, capacity GPM, at 40 Psi.														
	20	40	60	80	100	125	150	175	200	225	250	275	300	350	400
3	52	30													
5	87	73	62	50	40										
7.5		102	96	91	89	80	72	66	59	48	40	30			
10		110	107	102	99	95	91	86	81	76	71	64	58	46	32



50 GPM

6" PUMPING CURVES 50 G.P.M. "AP" Series

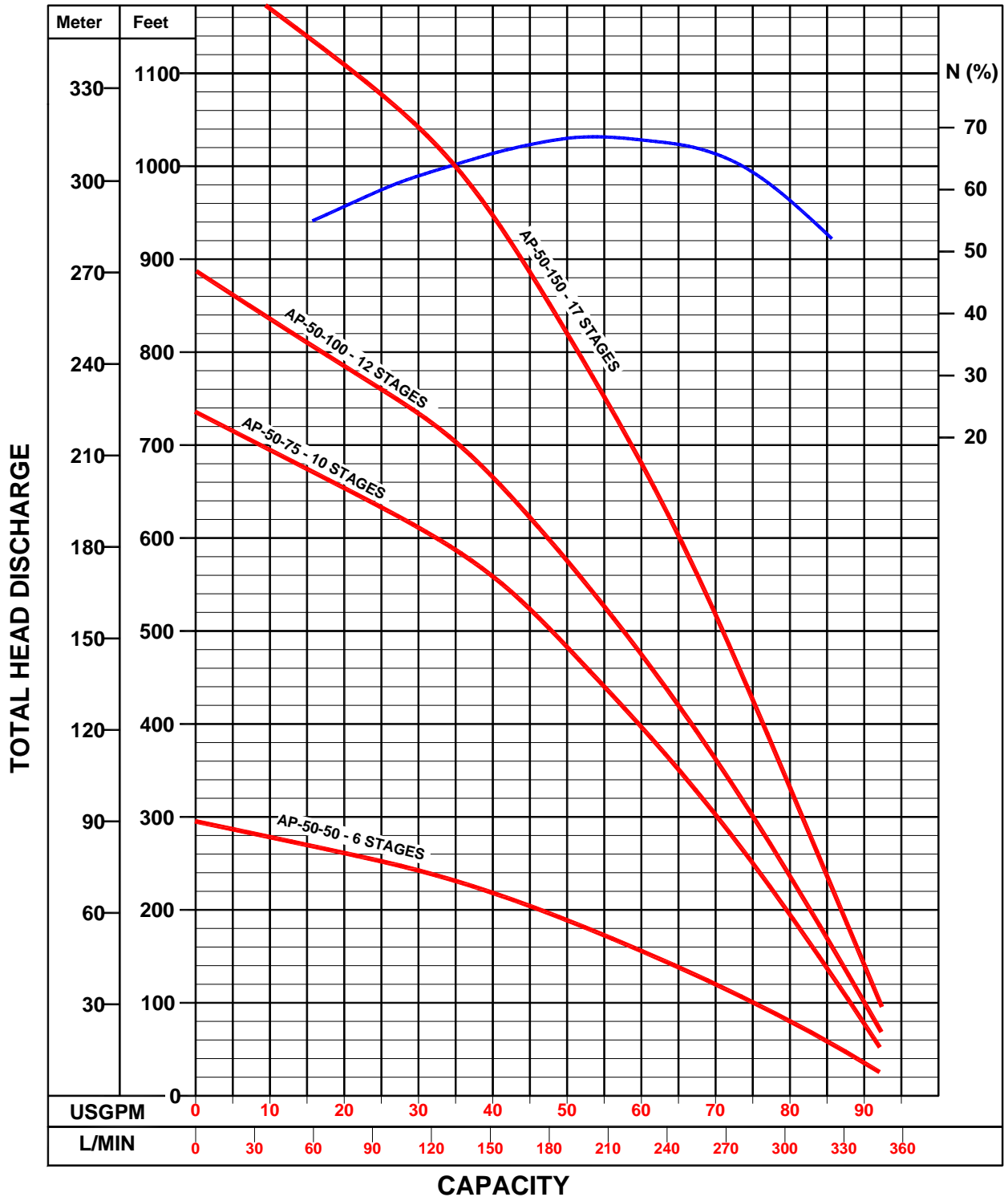



75 GPM

6" PUMPING CURVES 75 G.P.M. "AP" Series

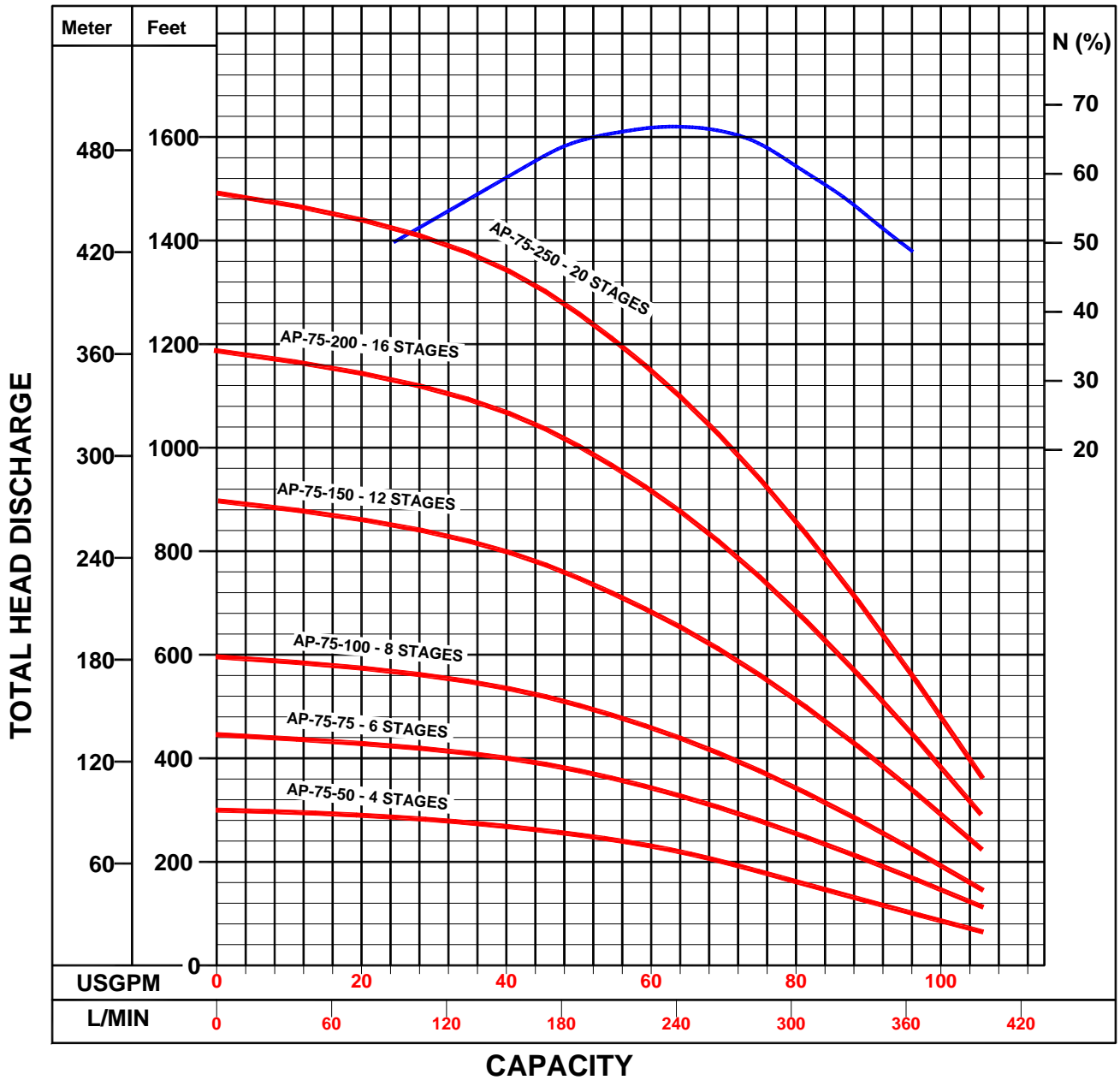



120 GPM

6" PUMPING CURVES 120 G.P.M. "AP" Series

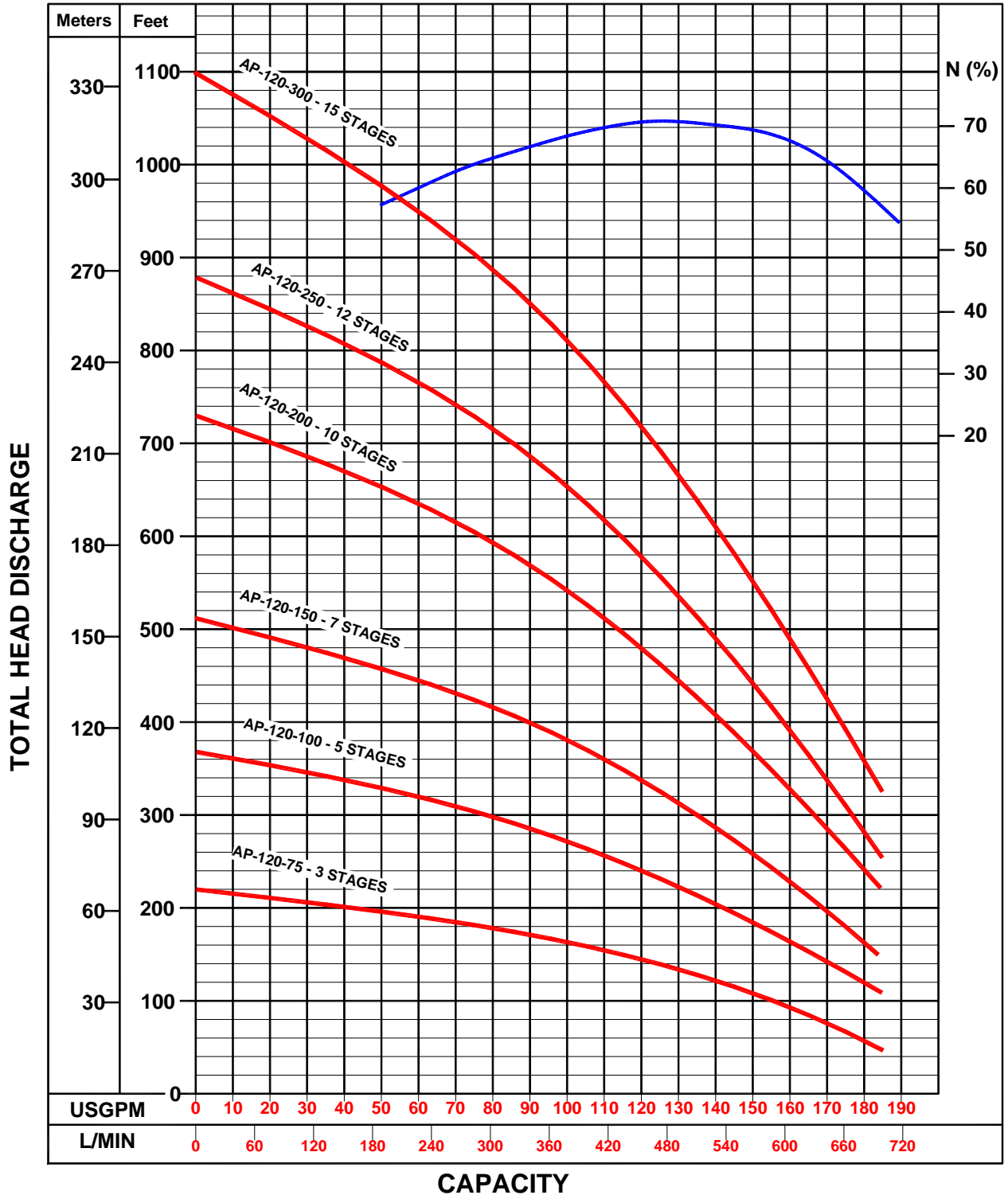



170 GPM

6" PUMPING CURVES 170 G.P.M. "AP" Series

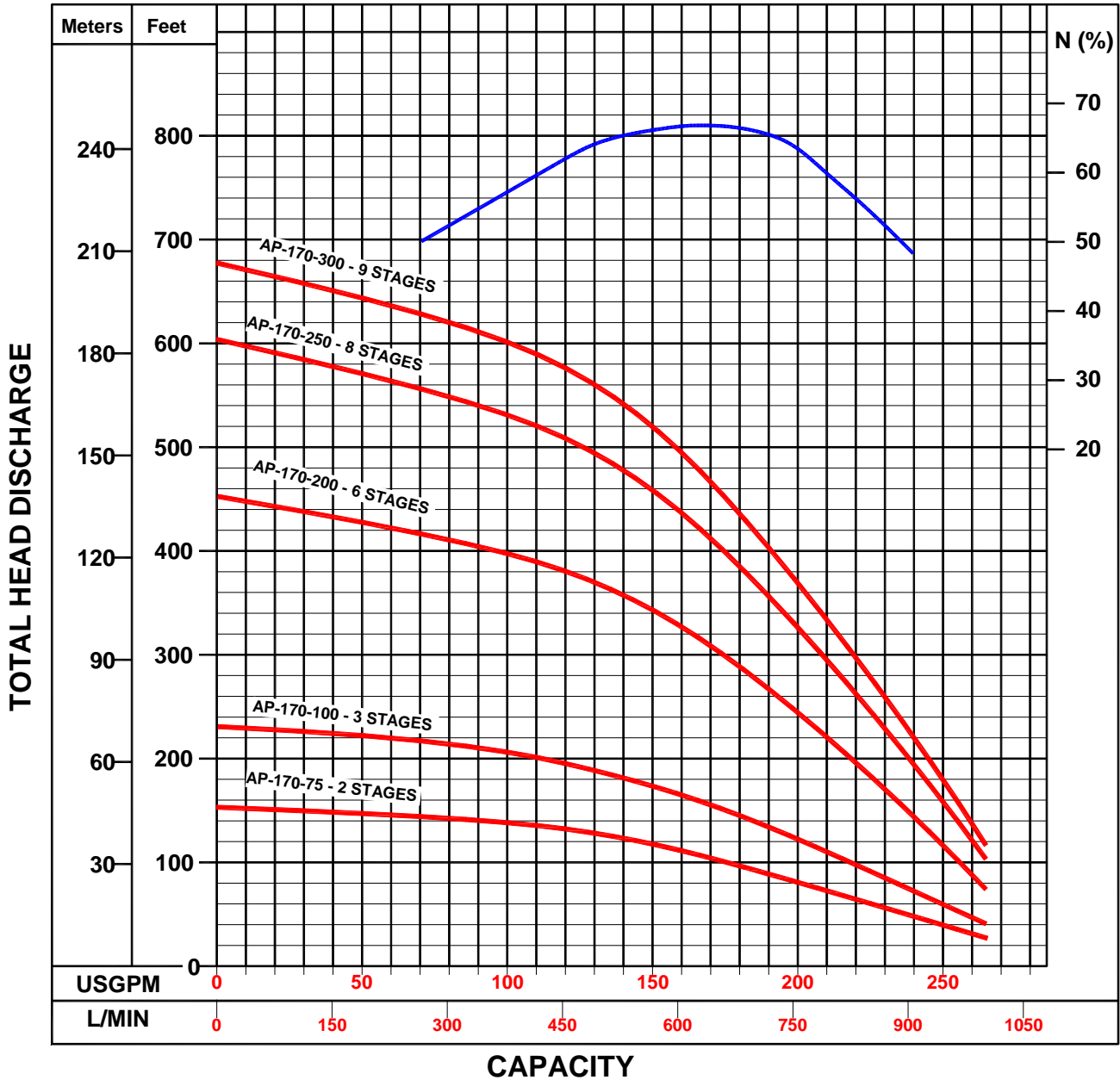



230 GPM

6" PUMPING CURVES 230 G.P.M. "AP" Series

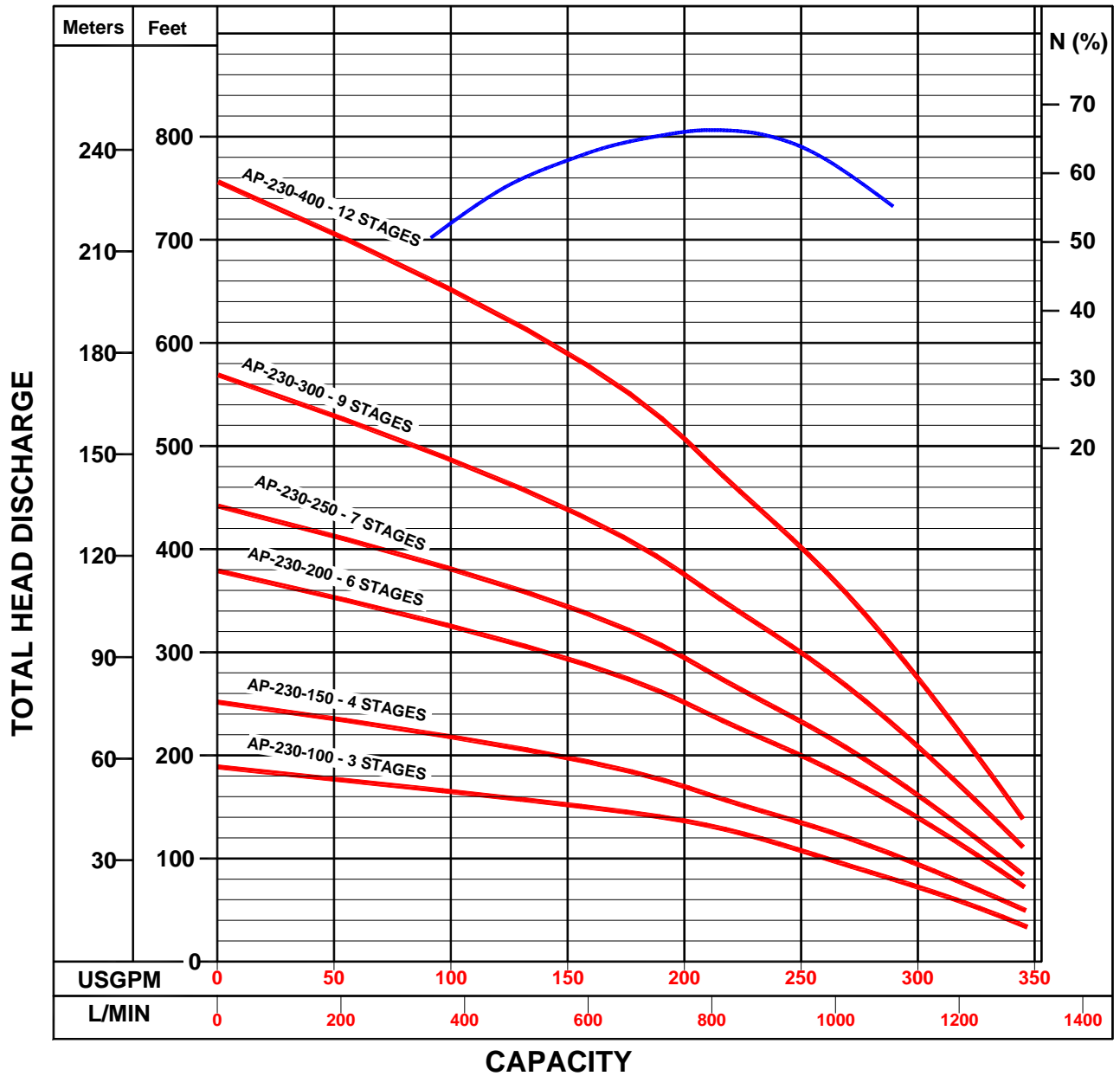



4" SUBMERSIBLE PUMP VARIABLE SPEED

SUBDRIVE 75 / 150



The POMPCO variable speed submersible pump is an innovative system that enable homeowners to obtain constant water pressure. People can now get city-like water pressure from their wells. This innovative variable speed pump is designed for applications with a wide range of flow demand, including large homes, ground source heat pumps, and sprinkler systems.

The POMPCO - Subdrive 75 is designed for a 3/4 HP pump mounted to a 1.5 HP Franklin Electric 3 phase motor.

The POMPCO - Subdrive 150 is designed for a 1.5 HP pump mounted to a 3.0 HP Franklin Electric 3 phase motor.



FEATURES & BENEFITS

- Constant water pressure with a wide range of settings (25 to 80 psi)
- Works with a standard motor between 1800 and 4800 RPM.
- Works with small pressure tanks or larger tanks already in place.
 - Minimum tank volume: 2 gallons (SUBDRIVE 75)
 - Minimum tank volume: 4 gallons (SUBDRIVE 150)
- Installation is as simple as installing a control box.
- Water faucets can be installed between wellhead and controller.
- Soft starts and stops mean less motor stress, therefore longer life span.
- Built-in diagnostics and protection.
 - Surge protection
 - Open / Short circuit
 - Underload
 - Undervoltage
 - Overheated controller
 - Locked pump
- Smart Reset technology allows well recovery before restarting the pump.



Part number	Model	Stages	HP	Volt	Ph.	Recommended pressure tank	Suggested list price	
SUBDRIVE 75								
531-0505	ST5-75-SB	19	1.5	230	3	2-gallons	3 072.00	
531-0510	ST8-75-SB	13	1.5	230	3	2-gallons	2 993.00	
531-0515	ST12-75-SB	11	1.5	230	3	2-gallons	2 972.00	
531-0520	ST20-75-SB	9	1.5	230	3	2-gallons	2 977.00	
SUBDRIVE 150								
531-0605	ST8-150-SB	22	3.0	230	3	4-gallons	5 124.00	
531-0610	ST12-150-SB	19	3.0	230	3	4-gallons	5 097.00	
531-0615	ST20-150-SB	15	3.0	230	3	8-gallons	5 055.00	
SUBDRIVE CONTROL								
151-0477	SUBDRIVE 75							1 790.00
151-0478	SUBDRIVE 150							3 179.00



4" SUBMERSIBLE PUMP VARIABLE SPEED

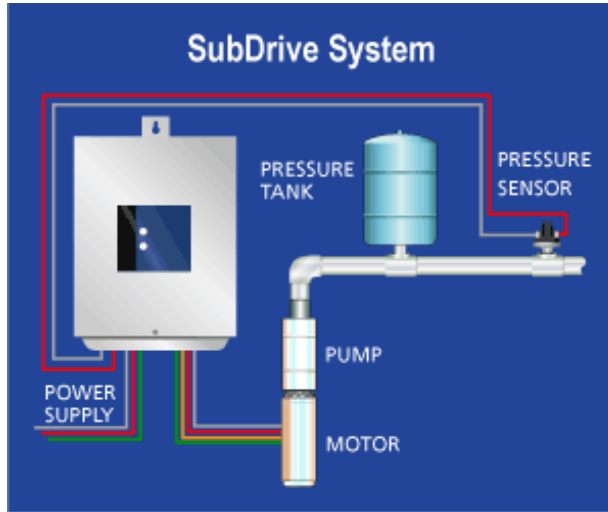

FAULT CODES

# of Flashes	Fault	Possible cause
1	Motor underload	Dry well Broken motor shaft
2	Undervoltage	Low line voltage
3	Locked pump	Sand-bound pump
4	NOT USED	
5	Open circuit	Loose connection Defective motor or cable
6	Short circuit	Defective motor or cable
7	Overheated controller	High ambient temperature in direct sunlight

PUMPING CURVE SB75 5 - 8 - 12 - 20 GPM

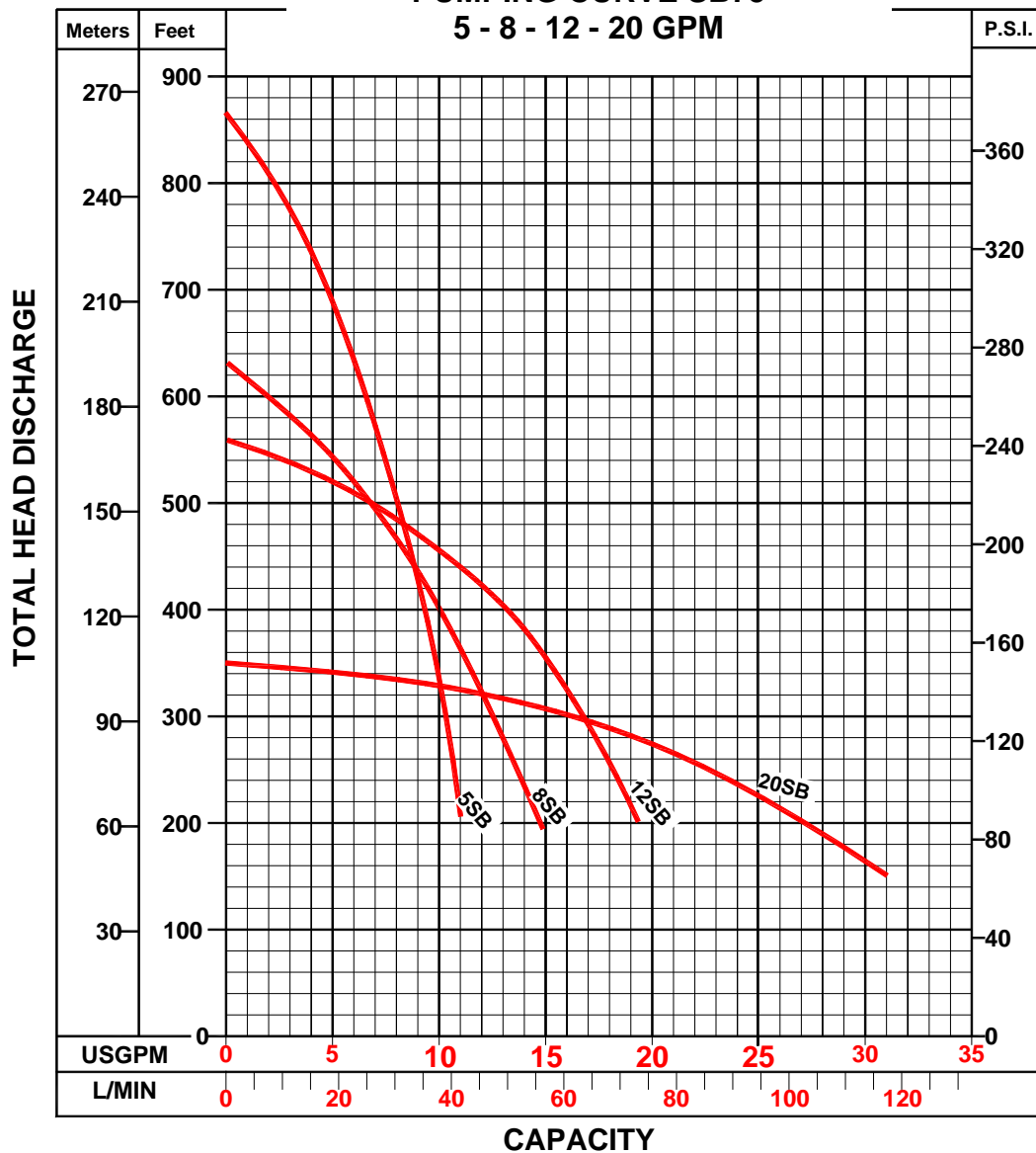



4" SUBMERSIBLE PUMP VARIABLE SPEED

**PUMPING CURVE SB150
8 - 12 - 20 GPM**

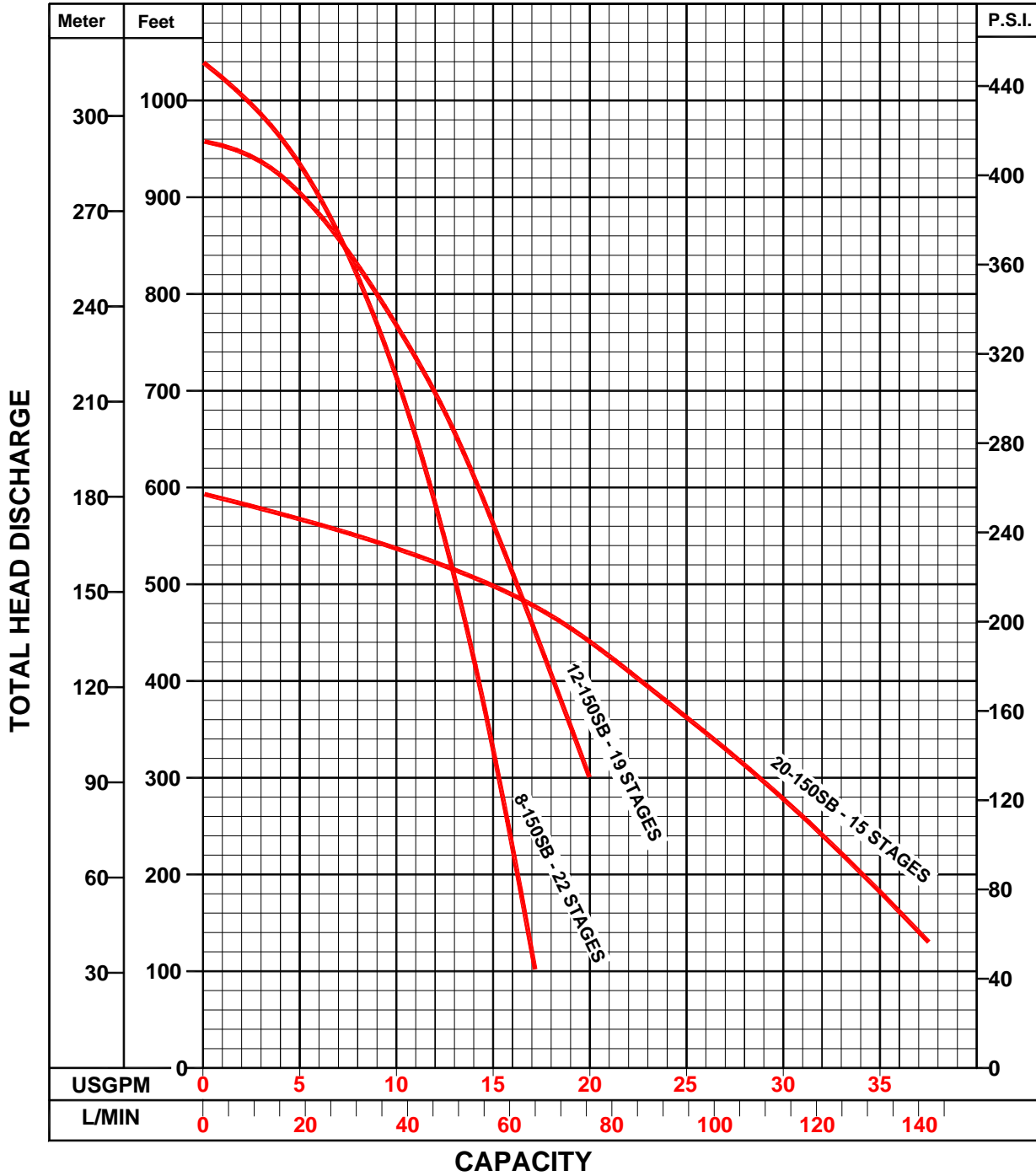

Wire sizing					
Copper wire size (AWG)	14	12	10	8	6
Maximum length between the electrical input and the motor (feet)	240	390	610	990	1540

"CP WATER - MONODRIVE" CONSTANT PRESSURE CONTROLLER

The CP Water - MonoDrive is the newest technological innovation in the constant pressure market. The MonoDrive provides the flexibility to convert a single phase conventional pump system into a constant pressure system simply by replacing the 3 wire control box with a CP Water - MonoDrive.

FEATURES & BENEFITS

- 1/2, 3/4 or 1 HP performance + Constant pressure with a wide range of settings.
- Easy installation - remove the 3-wire control box, install the MonoDrive.
- Works with a small pressure tank or larger tank already in place: minimum tank volume = 2 gallons.
- If the MonoDrive is damaged, it can be replaced with a 3-wire control box until a new MonoDrive is installed.
- Built-in diagnostics and protection.
 - Surge protection
 - Open / Short circuit
 - Underload
 - Undervoltage
 - Overheated controller
 - Locked pump
 - Smart Reset technology allows well recovery before restarting the pump.

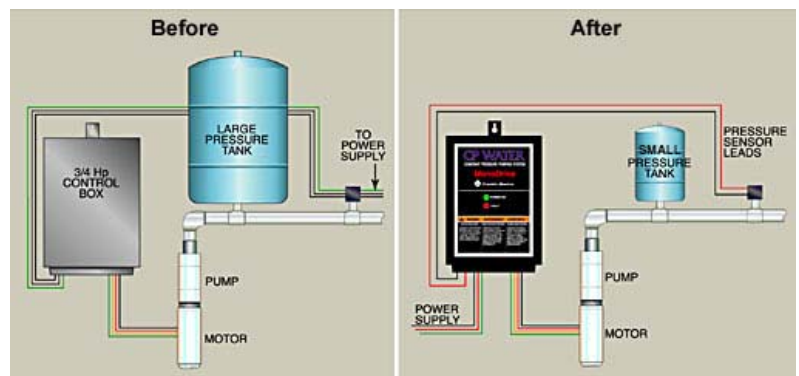
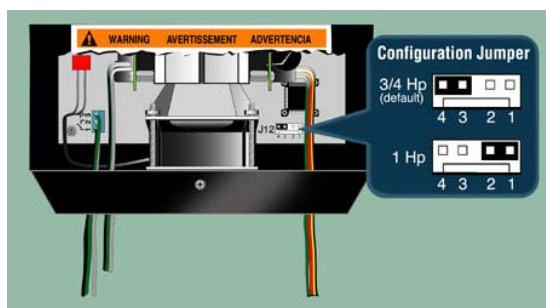

Part number	Model	Voltage	For motors	Suggested price list
151-0479	CP Water - MonoDrive	230	1/2 - 3/4 - 1.0 H.P.	1 526.00

SUBMERSIBLE MOTORS

MOTORS FOR SUBMERSIBLE PUMPS

4" - 2 WIRES + ground - 60 Hz

Order number	H.P.	kW	Volts	Phase	Length in	Suggested list price
151-0100	1/2	.37	115	1	9.53	541.50
151-0120	1/2	.37	230	1	9.53	541.90
151-0140	3/4	.55	230	1	10.66	670.60
151-0160	1	.75	230	1	11.75	735.40
151-0180	1 1/2	1.1	230	1	15.12	970.80

4" - 3 WIRES + ground - 60 Hz

Order number	H.P.	kW	Volts	Phase	Length in	Suggested list price
151-0240	1/2	.37	115	1	9.53	468.90
151-0260			230	1	9.53	469.20
151-0280	3/4	.56	230	1	10.66	573.30
151-0282			200	3	10.66	529.00
151-0285			230	3	10.66	529.00
151-0287			460	3	10.66	529.00
151-0300	1	.75	230	1	11.75	602.60
151-0305			200	3	11.75	586.00
151-0302			230	3	11.75	586.00
151-0304			460	3	11.75	586.00
151-0320	1 1/2	1.1	230	1	13.62	799.90
151-0322			200	3	11.75	711.00
151-0325			230	3	11.75	711.00
151-0330			460	3	11.75	711.00
151-0360	2	1.5	230	1	15.12	905.50
151-0362			200	3	13.62	786.10
151-0365			230	3	13.62	786.10
151-0370			460	3	13.62	786.10
151-0400	3	2.2	230	1	23.62	1 442.10
151-0405			200	3	20.62	1 152.30
151-0407			230	3	20.62	1 152.30
151-0410			460	3	20.62	1 152.30
151-0440	5	3.7	230	1	29.62	2001.30
151-0445			200	3	23.62	1 804.90
151-0450			230	3	23.62	1 804.90
151-0455			460	3	23.62	1 804.90

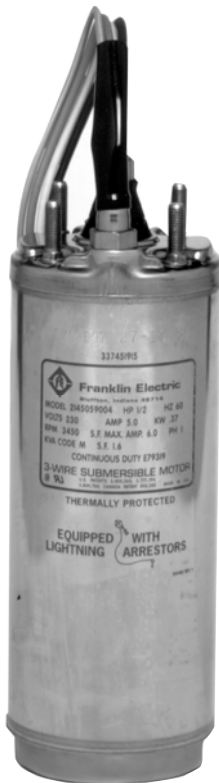



CONTROL BOXES and ELECTRONIC CONTROLS

CONTROL BOXES

For submersible 3 wire motors + ground - (1 phase)

Part number	H.P.	kW	Volts	Maximum size of wire	Shipping weight lbs	Suggested list price
151-0520	1/2	.37	115	#10 AWG	3.05	103.20
151-0540	1/2	.37	230	#10 AWG	3.05	103.90
151-0560	3/4	.55	230	#10 AWG	3.05	109.50
151-0580	1	.75	230	#10 AWG	3.05	113.70
151-0600	1 1/2	1.1	230	#2 AWG	6.63	159.00
151-0620	2	1.5	230	#2 AWG	6.63	270.00
151-0640	3	2.2	230	#2 AWG	6.63	334.90
151-0660	5	3.7	230	#2 AWG	6.63	486.70



MOTOR LEADS

Part number	Number of wires	Type of connection	Length in	Type of motor	Suggested list price
151-0720	3 + gr	single	48	4 inches	38.30
151-0740	3 + gr	single	100	4 inches	55.00
151-0760	2 + gr	single	48	4 inches	35.50
151-1071	3 + gr	single	150	6 inches	253.90

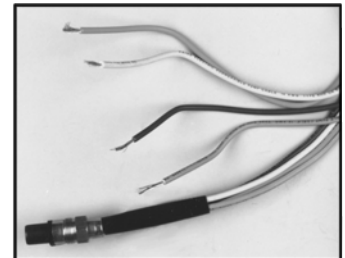

ELECTRONIC CONTROLS

PUMPTEC

PROTECTS AGAINST:

- Low yield wells
- Low voltage
- Air or gas locked pump
- Drop in water level
- Broken shaft or coupling
- Worn pump parts
- Can be adjusted from 2 to 90 minutes

#151-2000



PUMPTEC PLUS

PROTECTS AGAINST:

- Low yield wells
- Over / under voltage
- Overload
- Mud or sand clogging
- Air or gas locked pump
- Drop in water level
- Rapid cycling
- Faulty check valve
- Can be adjusted from 1 to 240 minutes

#151-2005



QD PUMPTEC

PROTECTS AGAINST:

- Low yield wells
- Air or gas locked pump
- Drop in water level
- Broken shaft or coupling
- Mounts in a Franklin Electric control box

#151-2010

- Low voltage
- Power surge
- Clogged well screen
- Worn pump parts
- Can be adjusted from 2 to 90 minutes



Part number	Model	Voltage	Motors	Suggested price list
151-2000	Pumptec	115 / 230	1/3 – 1 1/2 H.P.	365.80
151-2005	Pumptec Plus	230	1/2 – 5 H.P.	672.50
151-2010	QD Pumptec	230	1/3 – 1 H.P.	258.20

HIGH PRESSURE BOOSTER PUMP WGS

This type of pump is ideal for pressures up to 320 P.S.I. (**2 200 kPa**) and when boosting is necessary.

In addition to its efficiency, this pump is designed to be portable and easy to install.

The WGS high pressure booster pump is used in a wide range of applications such as:

- Home
- Gas station
- Restaurant
- Golf course
- Sprinkling system
- Farm
- Maple bush
- Marina
- Reverse osmosis

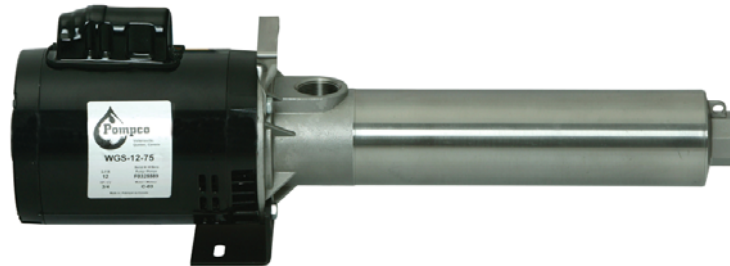

H.P.	G.P.M.	Stages	WITH MOTOR		
			Part number	Model	Price list
1/2	5	12	560-5010	WGS-5-50	877.60
	8	10	560-5050	WGS-8-50	860.60
	12	8	560-5100	WGS-12-50	841.00
3/4	5	16	560-5020	WGS-5-75	965.10
	8	12	560-5060	WGS-8-75	924.00
	12	10	560-5110	WGS-12-75	903.40
1	5	22	560-5030	WGS-5-100	1 091.30
	8	18	560-5070	WGS-8-100	1 035.40
	12	14	560-5120	WGS-12-100	995.80
	20	10	560-5160	WGS-20-100	959.50
1 1/2	8	20	560-5080	WGS-8-150	1 132.40
	12	17	560-5130	WGS-12-150	1 103.00
	20	13	560-5170	WGS-20-150	1 063.60
2	12	19	560-5140	WGS-12-200	1 212.80
	20	15	560-5180	WGS-20-200	1 181.60
3	12	26	560-5150	WGS12-300	1 515.80
	20	20	560-5190	WGS-20-300	1 481.00

PUMP:

- Stainless steel pump head and motor bracket
- Suction and discharge 1 1/4" NPT

MOTOR:

- Motor 1/2 H.P. to 2 H.P. - 115/230 Volts - 1 Phase - OPD
- Motor 3 H.P. - 230 Volts - 1 Phase - OPD
- **Other voltage and TEFC motors available as options**

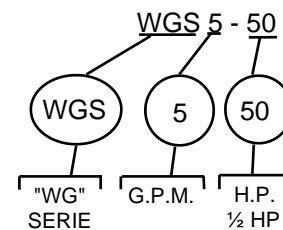



PUMPING CURVES WGS

WGS 5 GPM

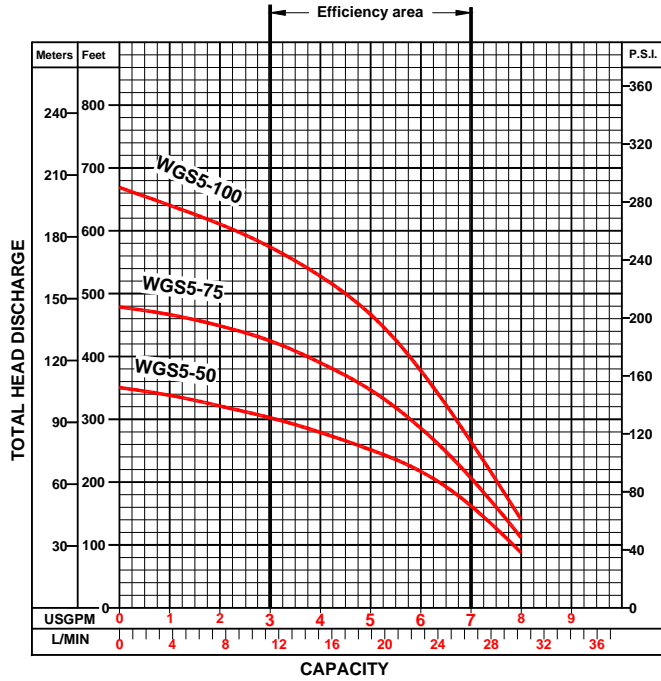

WGS 8 GPM

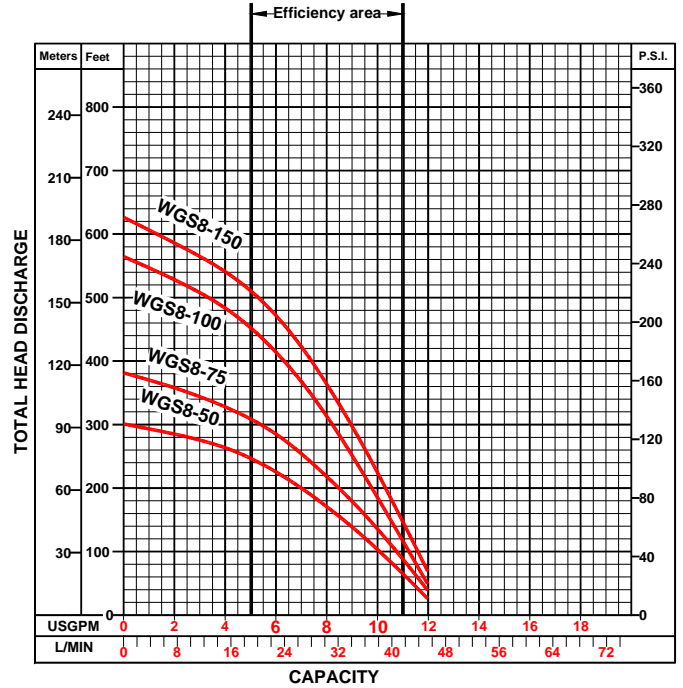

WGS 12 GPM

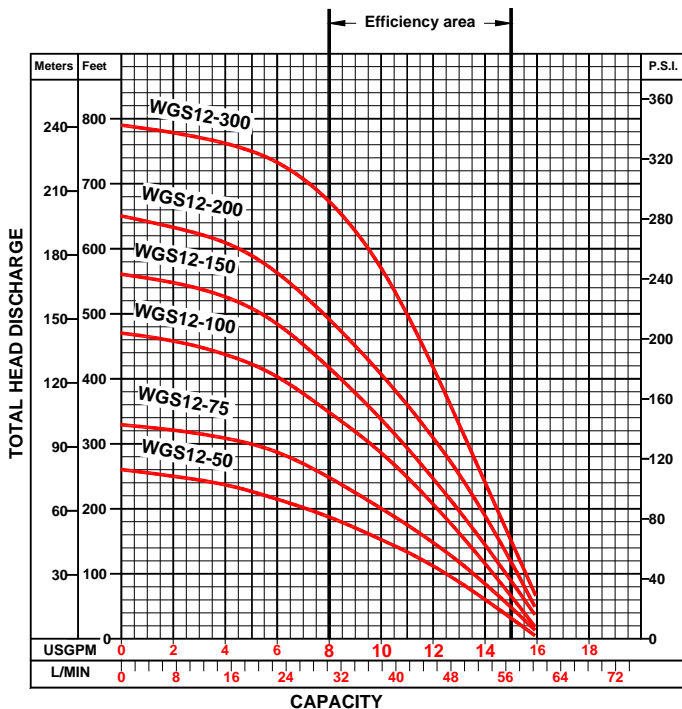

WGS 20 GPM

